

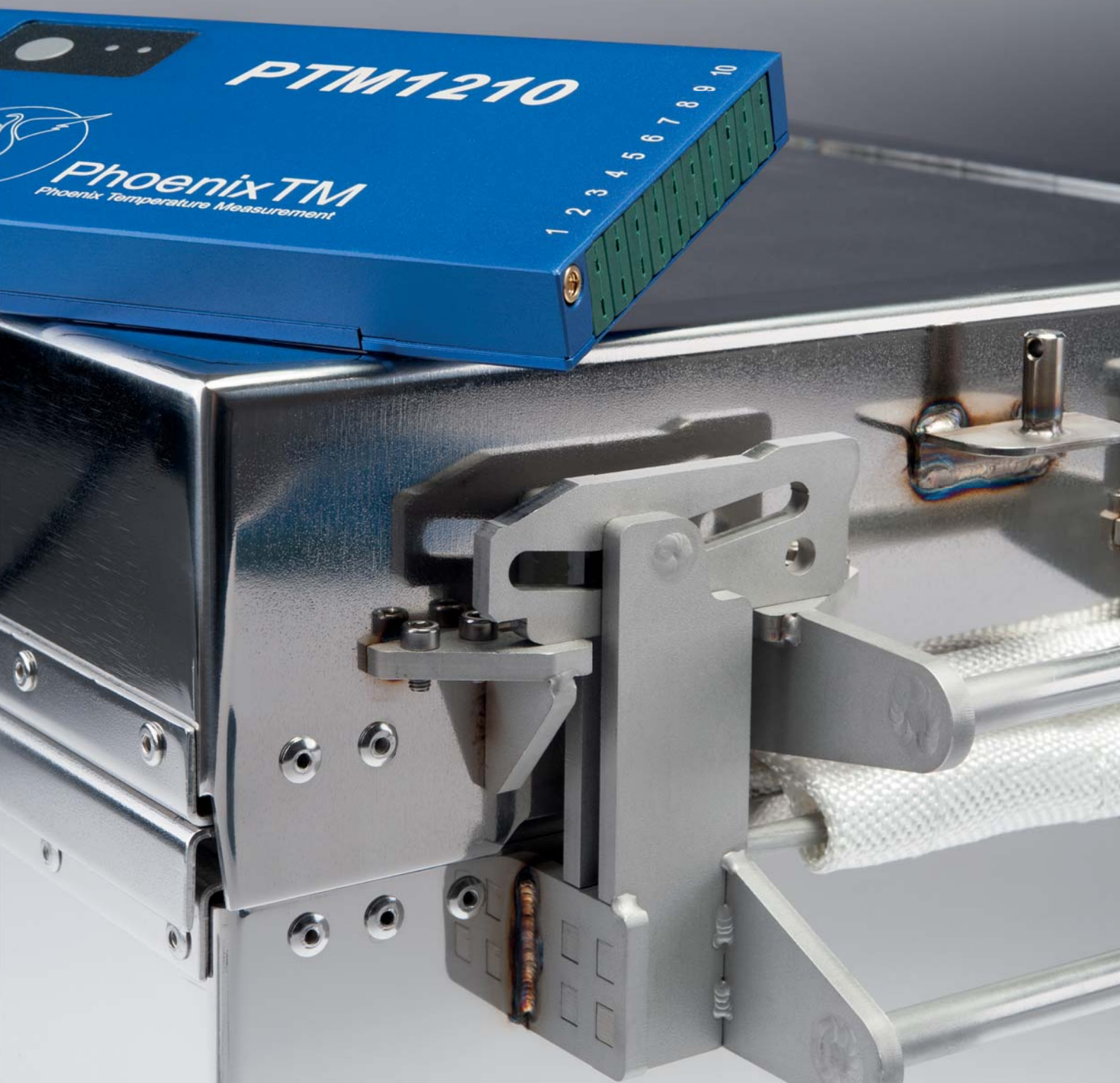

PhoenixTM 
Phoenix Temperature Measurement

Temperature Profiling Systems



Why temperature profile or survey?

Most furnaces have static control thermocouples measuring ambient temperatures, so often several thermocouples are available measuring the temperatures at a single point in a furnace, however, these are remote from the product.

How can you measure the product temperature?

Traditionally product temperatures have been measured by connecting a trailing thermocouple to the product and passing it through the furnace. Trailing thermocouples are expensive and cumbersome to use and process restrictions often preclude their use during normal production conditions, which affects process temperatures and therefore the value of information recorded.

When used, IR sensors also only measure temperatures at fixed points within a furnace but more importantly can only measure a product surface temperature so are not able to provide true product temperatures.

PhoenixTM systems are the solution:

The system is able to travel through the process, with the product, measuring the temperature at up to 20 critical points as the it passes through the furnace under normal production conditions.

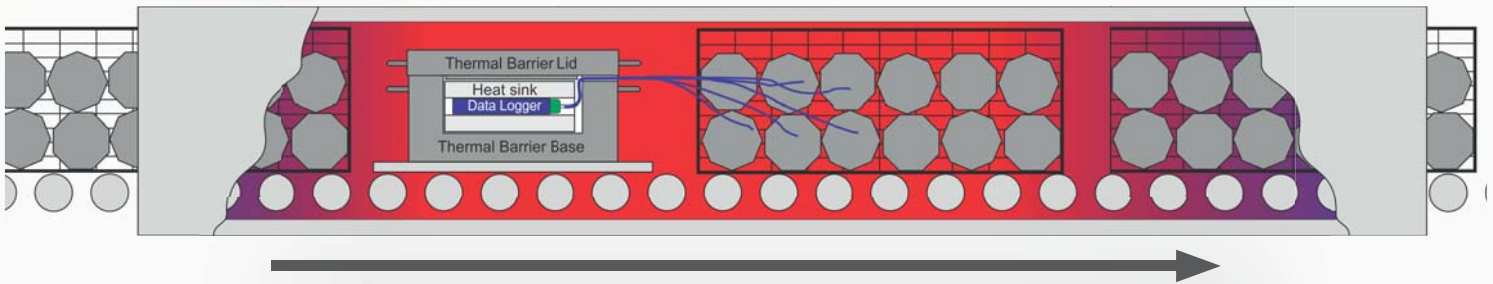

The PhoenixTM system provides detailed furnace and product temperature analysis to enable you to improve quality, reduce energy costs, optimize throughput and minimize process disruption.

A temperature profile is quick and easy to set up and run. Potential problems can be detected and reports generated to demonstrate process control and compliance. Regular measurements are possible and reports enable you to demonstrate process control and compliance.

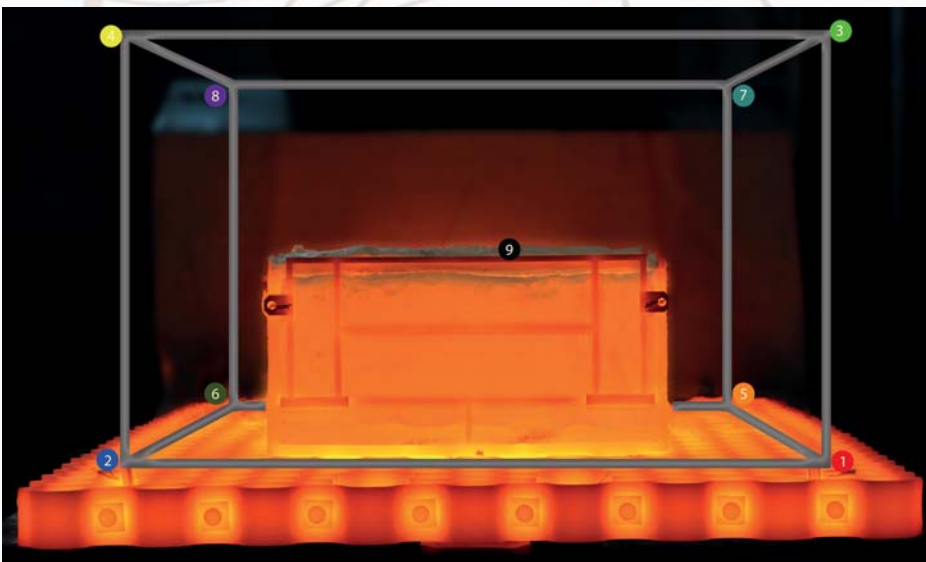

Surveying

Using Thermal View Survey software as part of a PhoenixTM system allows a AMS2750, CQI-9 or similar furnace surveys to be carried out quickly under production conditions minimizing production downtime.

Thermal View Survey Software creates AMS2750 and CQI-9 compliant reports and utilizing our unique 2-way RF telemetry allows control and analysis of the survey in real time.



PTM1200 Data Logger

All PhoenixTM data loggers are designed for use in harsh industrial environments. The electronics are protected by a robust, water resistant, aluminum case. The data logger design incorporates signal noise reduction and cold junction compensation to guarantee accurate and reliable data.

All loggers are shipped with a factory calibration certificate traceable to national standards. Optional certification at an ISO17025 certified laboratory (UKAS for the UK or DKD for Germany) can be supplied if required. A copy of the original, hand signed, calibration certificate and the calibration data is stored within the data logger and can be accessed via Thermal View software if required.

The range of data loggers available allows PhoenixTM to configure temperature profiling and surveying systems to suit individual process requirements.

PhoenixTM data loggers are available in 6, 10 and 20 channel versions in types K, N, R, S, T, J and B with mixed thermocouple combinations available.

Optional configuration are available to support two inputs of 4-20mA or 0-10 volts from alternative sensor types.



Two way Radio Telemetry

PhoenixTM data loggers can be equipped with an RF transmitter and a high temperature antenna that allow them to collect temperature data from the process and store it within the data logger's memory, while simultaneously transmitting it outside the furnace.

PhoenixTM has a unique two way telemetry capability that allows for auto data 'catch up' if the RF signal is temporarily interrupted. Additionally this allows for an analysis window to be opened mid process and for full process details to be analysed. The transmission range can be increased by adding additional, wireless, repeaters allowing a quick installation for the PC positioned in a convenient and secure location.

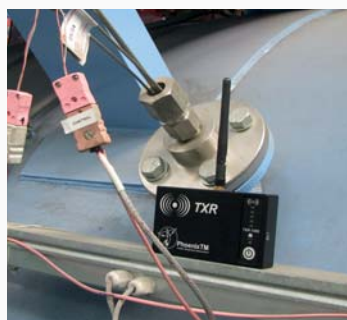

General Heat Treatment

Temperatures up to 1200°C / 2190°F



TS01

Developed for processes up to **800°C / 1290°F** the Phoenix™ TS01 Thermal Barrier range is perfect for applications in the aluminum, glass and steel industries. Microporous insulation and a heat sink provide protection against the temperatures inside the furnace.

Made from high grade stainless steel, with an easy to replace thermocouple wear strip, the TS01 Thermal Barrier range is robust and durable.



TS02

Processes such as carburizing at temperatures up to **1000°C / 1830°F**, require a Thermal Barrier which can withstand several changes in temperature, pressure, and aggressive atmospheres.

Strengthened and reinforced at critical points to minimize distortion, Phoenix™ TS02 Thermal Barriers are designed to offer full protection to the Data Logger in demanding conditions. TS02 Thermal Barriers are fitted with extra heavy duty catches, dual thermocouple exits and user replaceable wear strips to help extend the life of the Thermal Barrier and reduce the need for costly repairs.

Additional protection is available for use in the high-pressure gas quenching.



TS03

For processes up to **1200°C / 2190°F** Phoenix™ TS03 Thermal Barriers are manufactured from high temperature heat resisting alloy, ultra high temperature insulation, strengthened and reinforced at critical points to minimize distortion and fitted with extra heavy duty catches, dual thermocouple exits and user replaceable thermocouple wear strips to help extend the life of the thermal barrier.



TS27

For processes without a controlled atmosphere a TS27 Thermal Barrier can provide protection for the data logger in temperatures up to **1200°C / 2190°F**. By using evaporative water technology combined with high temperature alloys and microporous insulation the TS27 Thermal Barrier provides compact design with optimized performance.



PhoenixTM Systems

PhoenixTM provide a complete system: a data logger to record temperatures using thermocouples, a Thermal Barrier to protect the data logger from the heat of the furnace and analysis software to quickly interpret, evaluate and report on your process. The system comes with carry case, user manual and other accessories depending upon on the system configuration.

TUS (Temperature uniformity survey)

Temperature Uniformity Surveys are generally carried out to comply with standards such as AMS2750 and CQI-9 to ensure that a furnace is performing to a given specification.



Temperature Profiling in Continuous Furnaces

A PhoenixTM system runs through the oven together with your product, measuring the temperature at up to 20 points. Set-up is quick and easy and can be run under normal production conditions minimizing production downtime. The system will provide detailed information on the actual temperatures of your products as they pass through the furnace enabling you to improve quality, reduce energy costs, optimize throughput, minimize maintenance disruption whilst enabling you to demonstrate process control and compliance

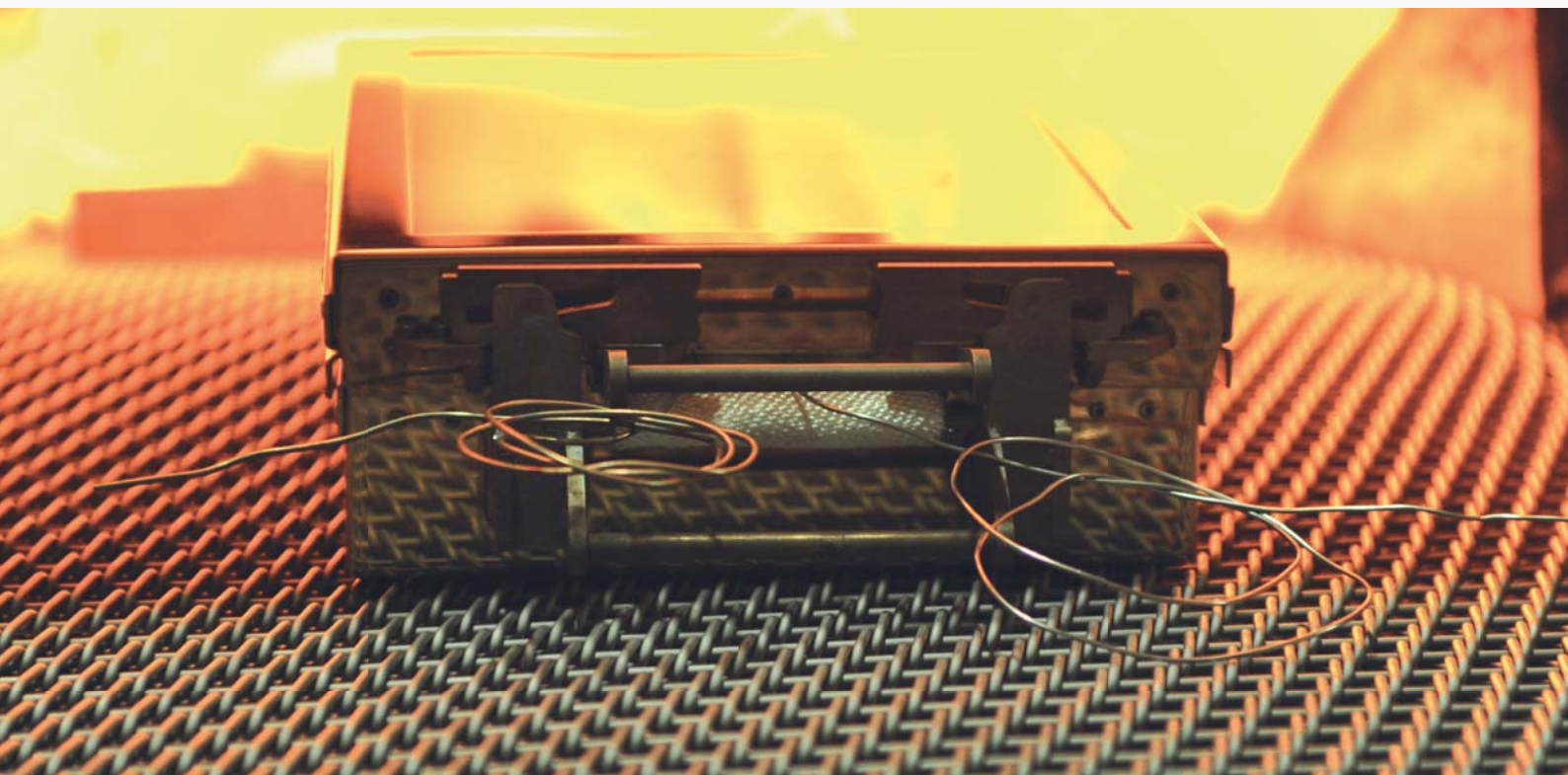

Systems for Specific Applications

Heat Treatment with Oil Quenching

TS12

Carburizing in an integrated quench (IQ) furnace is a common heat treatment process for the manufacture of gears, etc., and oil is the most commonly used quench medium. During the oil quench, products within the batch can sometimes experience distortion problems, which may have several causes including flow patterns and temperature variations. Monitoring the temperature at various depths within the product and locations around the batch, can provide valuable data on the temperature profile of the part throughout the complete heating and cooling cycle.



The Phoenix™ TS12 Series Oil Quench System (Patent Pending GB1509136.6), uses a multi-channel, high temperature data logger protected by a thermal barrier which uses a two part insulation system. The inner thermal barrier is completely sealed to prevent oil contaminating the data logger.

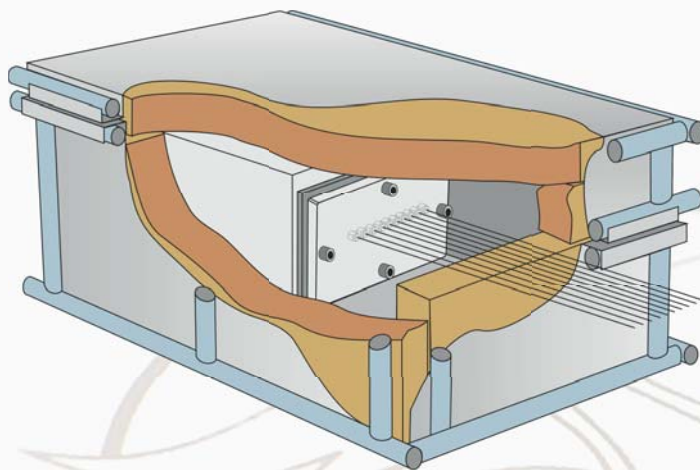

The outer insulation layer provides additional heat protection in the furnace, but is sacrificial during the oil quench. The system is designed not only to go through the complete heat treatment cycle including the oil quench, but has enough thermal capacity to go through a wash cycle afterwards.





Heat Treatment of Aluminium



TS06

Built for solution treatment and age hardening where high temperatures and water quenching are part of the process. These Thermal Barriers use the principle of evaporating water to keep the data logger cool in the furnace, and can re-fill in the quench to allow it to undergo a further heating period as is normal in these processes. During the quench a water tightseal is maintained by using heavy duty gaskets and stainless steel compression glands around the thermocouples, this affords maximum protection to the data logger.



Aluminum Brazing

TS08

Built specifically for Aluminum brazing applications the TS08 thermal barriers are designed to eliminate exposed insulation, protecting against acid attack and extending the life of the thermal barrier. Oxygen presence within the thermal barrier is reduced by maximizing the amount of nitrogen in the insulation material during manufacture which minimizes possible oxygen contamination in the furnace. For processes sensitive to oxygen contamination the TS08 can be fitted with an optional facility to allow a nitrogen purge of the thermal barrier prior to each run, significantly reducing oxygen contamination.

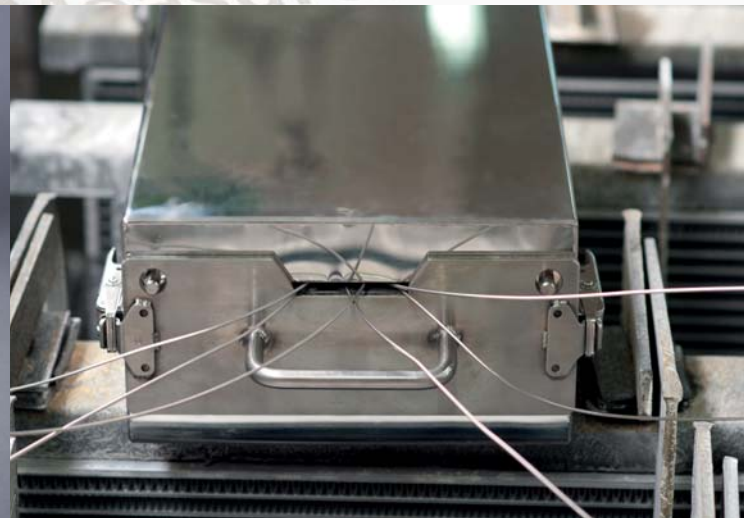

Systems for Specific Applications

Ceramic Firing

TS05

Developed for the ceramic industry, the Phoenix™ TS05 Thermal Barriers travel beneath the kiln car for a sustained period at moderate to high (300°C) under car temperatures.

Depending upon the process thermocouples types K, N, R, S or B are available.





Built from high grade stainless steel these Thermal Barriers use evaporative water technology to keep the data logger cool and protect against mechanical damage and the dusty environment of a ceramic kiln.

TS05 thermal barriers have detachable thermocouple sockets which can be mounted remotely from the thermal barrier so that thermocouples can be fitted easily and the length of the thermocouples can be reduced.



PhoenixTM systems are also available for roller hearth kilns. The system runs through the firing zone with the product and can measure both product and air temperatures.



Systems for Specific Applications

Slab and Billet Reheating

TS07

Developed for the very high temperatures of the steel industry !

TS07 thermal barriers are specifically developed for reheat processes in the steel industry where temperature data from deep inside the slab or billet is required. Manufactured using graded insulation layers and an evaporative inner barrier, the TS07 range accepts 10 and 20 channel data loggers and is designed for repeated use at temperatures up to 1350°C.



Developed from many years of experience the TS07 has many features specifically for this harsh environment. The data logger fits into an inner tray providing extra protection for the connections whilst clamping thermocouples to ease handling.

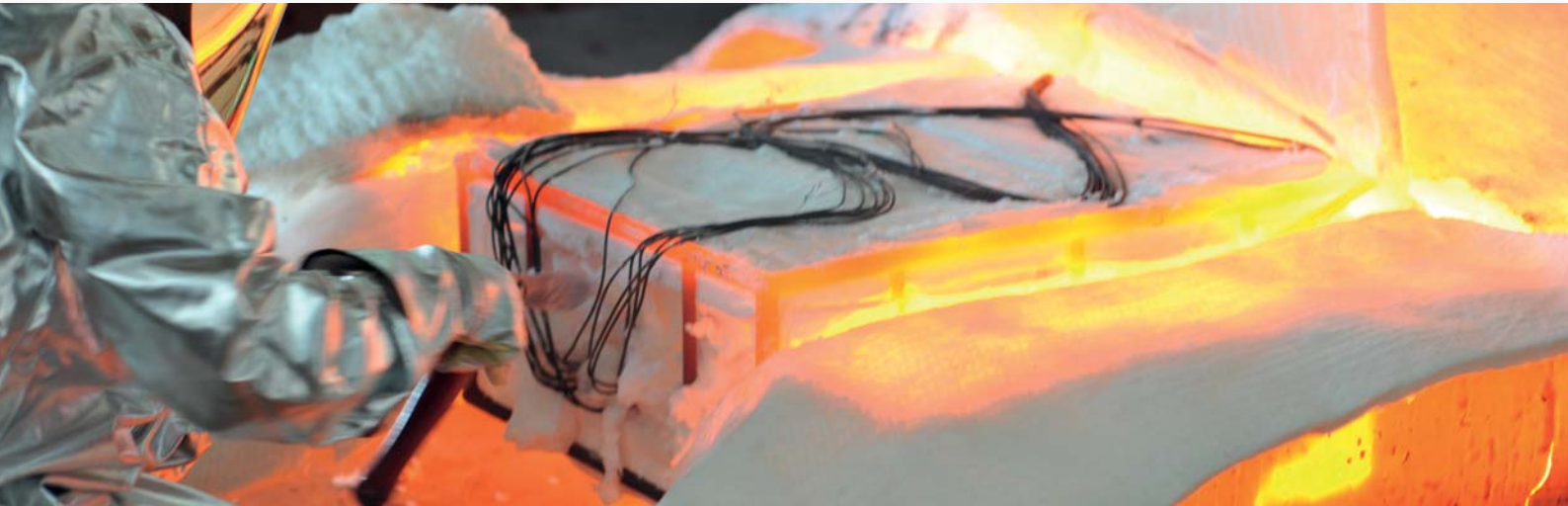

The TS07-100 Thermal Barrier System is specifically designed for Mini-Mill (CSP) applications. It provides thermal protection for the data logger combined with a support arm for the thermocouples measuring both surface and atmosphere temperature. After preparation the system is lowered onto the moving slab using the foldable suspension arms by an overhead crane. When positioned on the slab the arms are lowered to ensure the low height profile of the system is maintained.



Coating Applications

TS04

TS04 Thermal Barriers are designed specifically to meet the demands of the paint and powder coating industry. Whilst providing a high level of thermal protection the aluminium case and silicone free construction is both light and easy to use. Several sizes are available to suit 6, 10 or 20 channel data loggers and for longer processes include a heatsink to extend the thermal duration.



The barriers for curing applications are manufactured from aluminum to reduce weight and aid ease of use.

An exact calculation of the insulation / heatsink ratio provides a maximum thermal performance as well as a minimizing the size of the Thermal Barrier.

Thermocouples

PhoenixTM finishing thermocouples are manufactured using the highest quality materials and conform to ANSI 96.1 special limits specification. The thermocouples are designed to withstand rough handling and uniquely include user replaceable sensors to minimize long term running costs. Available as magnetic, clamp or exposed junction, the thermocouples are PTFE insulated, triple wrapped with stainless steel braid, and have a final overall PTFE insulation.

We can also offer bespoke solutions to suit Individual customer length, fixing methods, and insulation material requirements.

Thermocouples with magnets for surface and air temperature measurement.



Thermocouples with clamps for surface and air temperature measurement.

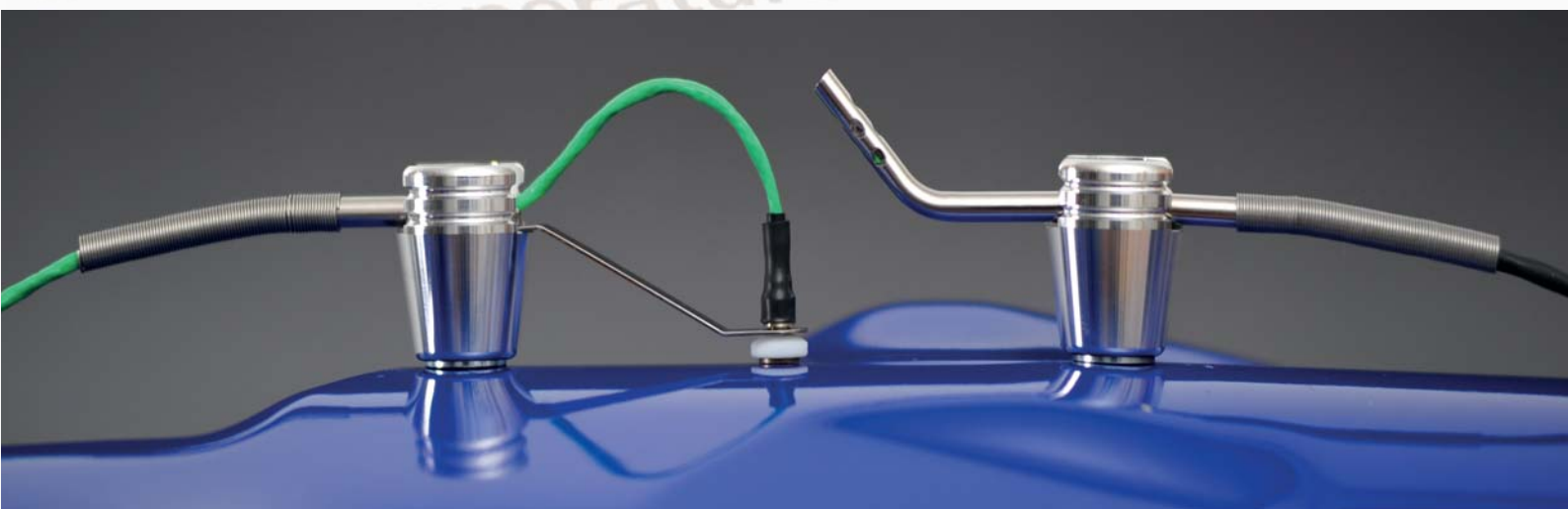

Systems for Specific Applications

Food Processes

TS14

The TS14 system has been specifically designed for the food industry and provides enhanced levels of thermal and mechanical protection for the data logger inside the process. It is waterproof and suitable for use in frying, steam cooking, chillers and blast freezers. The housing is made of a food contact approved stainless steel so that it can travel safely through the process during normal production. The low height submersible design combines high thermal performance with ease of use in challenging food processing environments.



A range of thermal barriers is also available for higher temperature baking processes. Special designs are also available to meet individual customer application requirements.

Systems for the food industry are supplied with PTM1200NT data loggers, with an operating range of -40°C to $+80^{\circ}\text{C}$ / -40°F to $+176^{\circ}\text{F}$. Available with Type T or Type K thermocouples offering a measurement range from -190°C - $+400^{\circ}\text{C}$ / -328°F to $+752^{\circ}\text{F}$.



Thermocouples

Thermocouples are available in many different variations. For temperatures up to 250°C / 482°F we provide flexible PTFE insulated thermocouples. Glass fibre sheathed thermocouples and Ceramic fibre sheathed thermocouples provide a flexible thermocouple option for higher temperature applications.

All thermocouples are ready-to-use with a mini plug for connection to the data logger. If necessary thermocouples can be supplied with a batch certificate or individually calibrated.

Thermocouples are available in many different variations. For temperatures up to 250°C / 482°F we provide flexible PTFE insulated thermocouples. Glass fibre sheathed thermocouples and Ceramic fibre sheathed thermocouples provide a flexible thermocouple option for higher temperature applications.

For very high temperatures applications or when flexibility is not an issue we recommend mineral insulated thermocouples with a diameter from 1mm to 3 mm. These thermocouples are suitable for use up to 1300°C / 2372°F have have nichrome or inconnel metal sheath.

PTFE insulated thermocouples are used for temperatures up to 250°C / 482°F. Fitted with magnets, clamps or with an open junction to suit various kinds of attachment.

PTFE is an inert material resistant to common solvents and acids.



For temperatures from 250°C up to more than 1000°C mineral insulated thermocouples are the first choice. The thermocouple wires are insulated by magnesium oxide and protected by a high grade alloy sheath. These thermocouples are available in various diameters and lengths.

Thermocouples can be welded, mechanically held, or retained in holes to record temperature at critical points.



Type "K" or type "N"
Probes in 1.5, 2 oder 3mm diameter.

Always the right thermocouple for your application !

For special applications we can supply thermocouples with other insulation material as well as individual lengths and fixing methods.

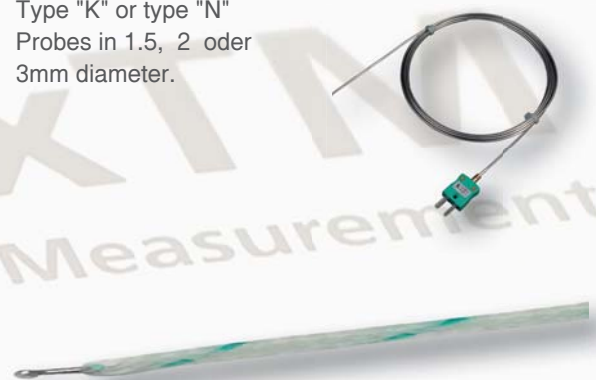

Analysis Software

Thermal View

The easy way to get a perfect result!

Phoenix™ 'Thermal View' is a powerful, comprehensive software package for analysing process temperature data to optimize the operation of the process and confirm process compliance.

Screen layout is clear, concise, and intuitive making the software user friendly, uncluttered and easy to use without compromise to the analysis detail available.

Thermal View is available in a number of configurations to meet the requirements of different industry applications:

ThermalView Plus

The standard software for heat treatment temperature profiling requirements.

Functions:

- View Temperature Data
- Time above Temperature
- Max, Min, Mean
- Rise and Fall
- Maximum Difference
- Tolerance Band
- Reference Profile
- Onscreen Notes
- Print Report
- Export (CSV)
- Real Time Data
- Online Help
- Process Library
- Product Library
- Area above °C
- Calibration Corrections
- Merge Files



ThermalView Finishing

Specifically design for paint and powder finishing applications.

In addition to the PLUS functionality, the Finishing-Software provides instant visual confirmation of compliance to curing specification and provides a one page report summary for easy archiving and process traceability.

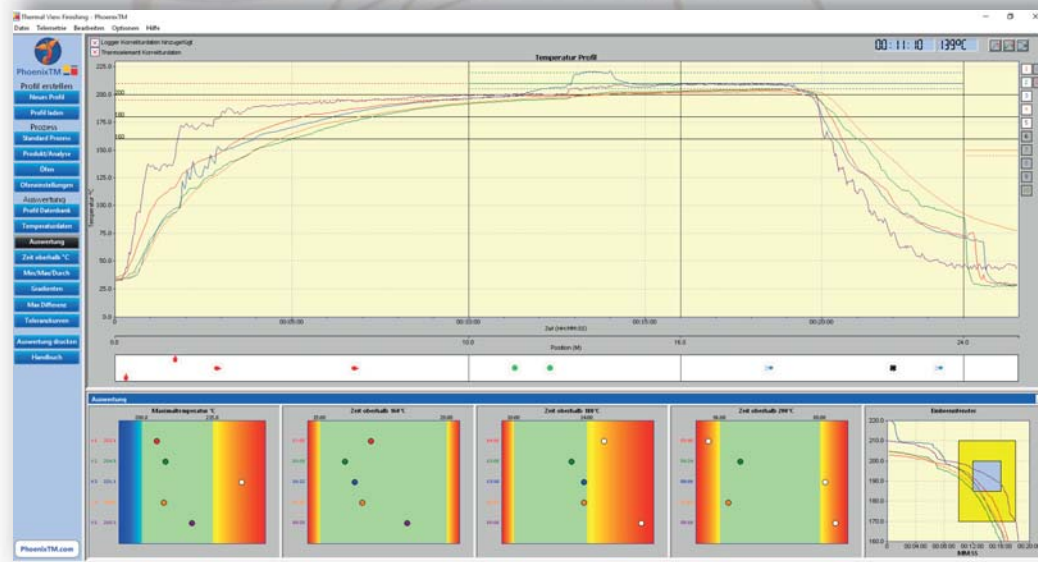



ThermalView Survey

All the essential functions required to monitor, and analyse TUS surveys and produce AMS2750 and CQI-9 compliant reports.

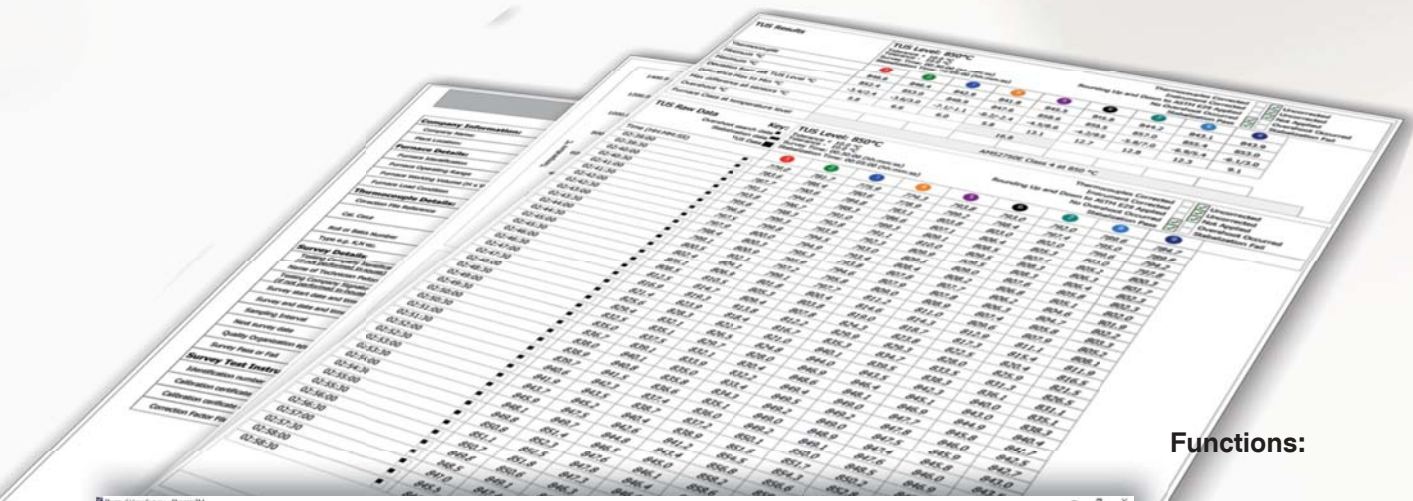

Functions:

- AMS2750 and CQI-9 Analysis
- View Temperature Data
- Onscreen Notes
- Printed Report
- Export (CSV)
- Real Time Data
- Online Help
- TUS Frames Library
- TUS Level Library
- TUS Results
- Calibration Corrections
- Merge Files

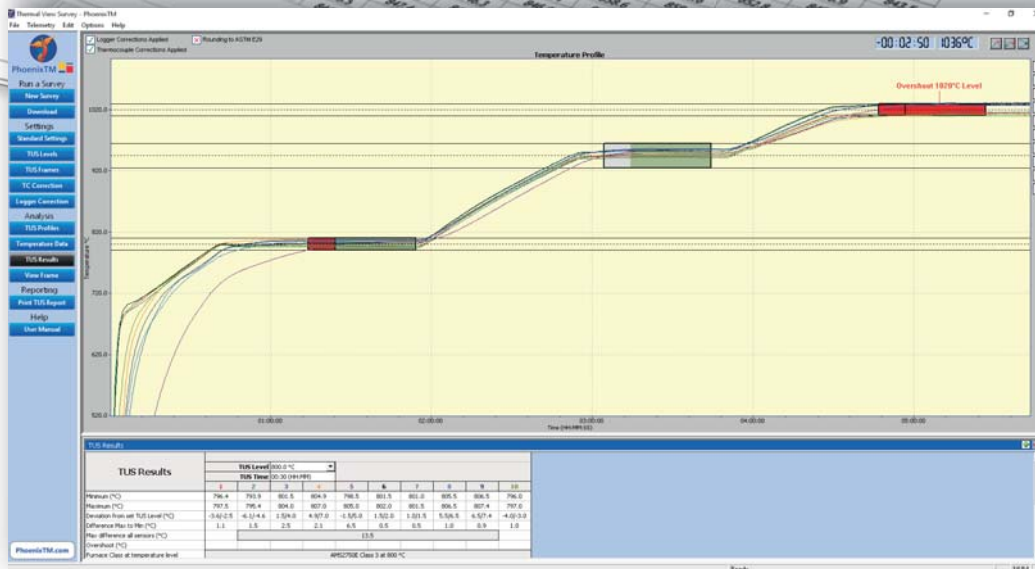

ThermalView Food

In-depth analysis and visual confirmation of calculations enables efficient process validation and traceability in the food industry.

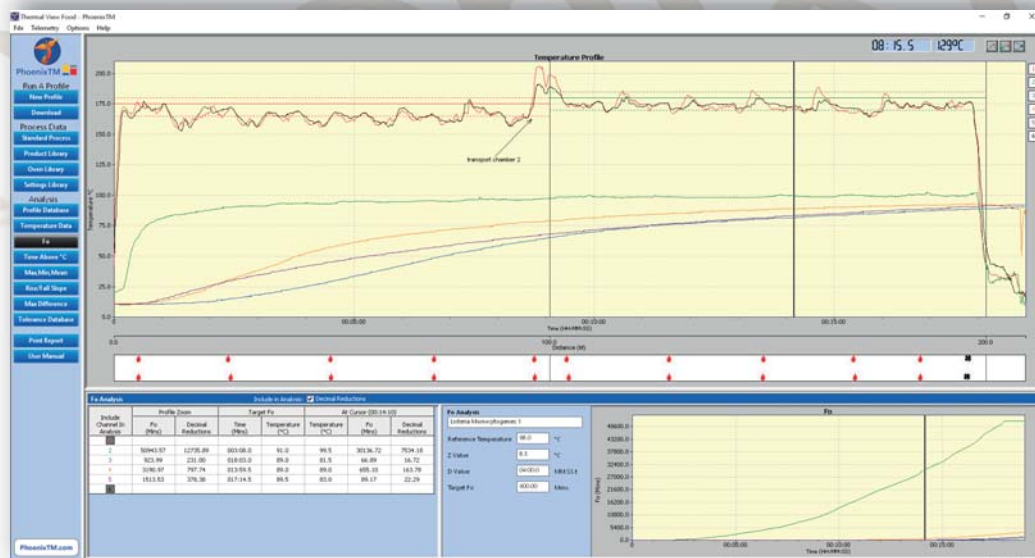

- F0/Pu process analysis
- View Temperature Data
- Time above Temperature
- Max, Min, Mean
- Rise and Fall
- Maximum Difference
- Toleranceband
- Reference Profile
- Notes
- Printed Report
- Export (CSV)
- Real Time Analysis
- Online Help
- Product Library
- Oven Library
- Settings Library
- Calibration Corrections
- Merge Files



PhoenixTM

PhoenixTM has evolved to bring innovation, quality and simplicity to the process of temperature profiling.

With over 60 years of combined temperature profiling experience, the senior PhoenixTM personnel have a deep understanding of all aspects of the design of products for these industries, and most importantly, have good knowledge of the processes in which they will be used. Customers can be assured that temperature monitoring systems supplied by PhoenixTM will have true experience designed into them, will be built to the highest quality standards, but will also be easy for operators to use.

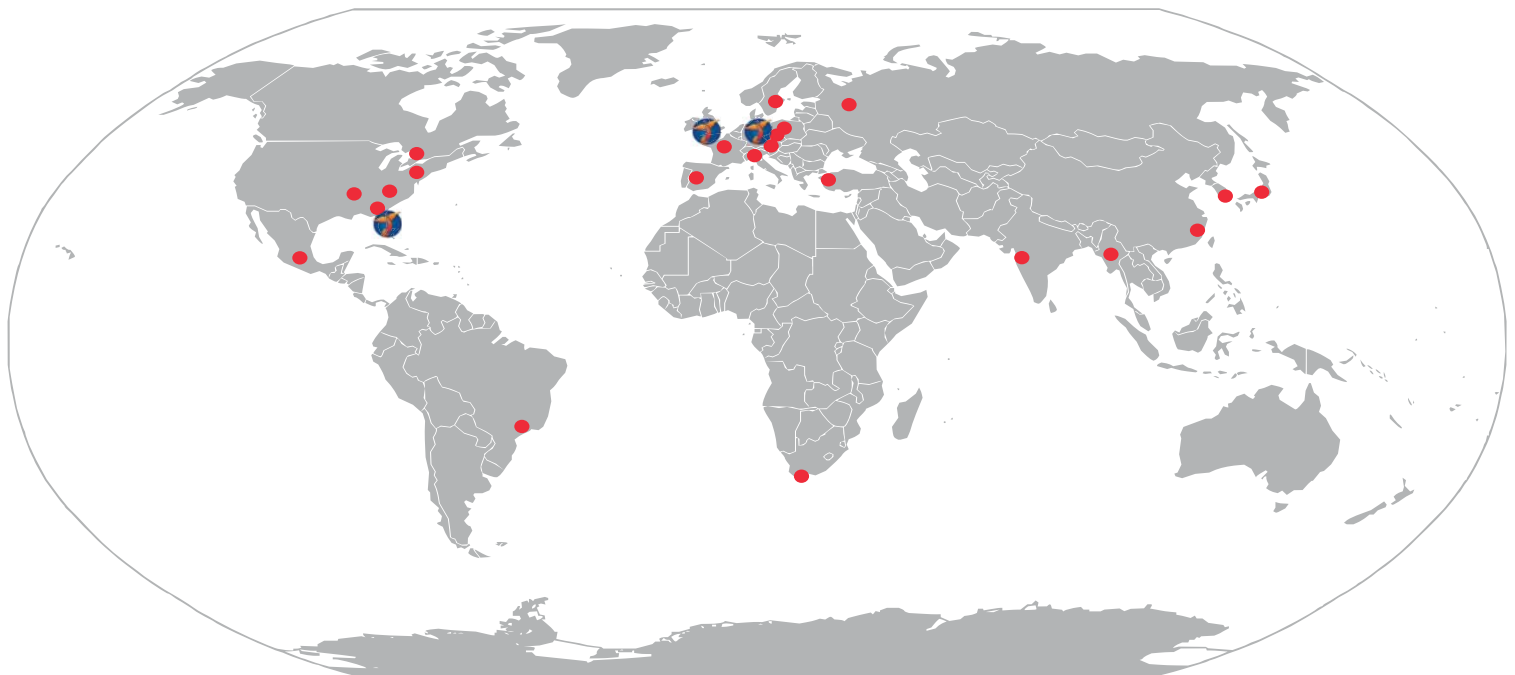

Sales and Service

With offices in the UK, Germany and the USA and a worldwide network of agents and partners we can provide customers with full and competent local service and support.

Please contact your local PhoenixTM office for details of agents and partners in your area.

We are looking forward to your inquiry !

PhoenixTM GmbH



Dehmer Str. 48
D- 32549 Bad Oeynhausen
Tel.: +49 5731 30028 0
Fax: +49 5731 30028 14

www.Phoenixtm.de
info@phoenixtm.de



PhoenixTM Ltd



25 Earith Business Park
Meadow Drove,
Earith, Cambridgeshire
PE28 3QF, UK
Tel.: +44 1353 223100

www.Phoenixtm.com
sales@phoenixtm.com

PhoenixTM LLC



4500 140th Avenue North
Suite 101,
Clearwater
FL 33762 USA
Tel.: +1 (727) 608 4314

www.Phoenixtm.com
info@phoenixtm.com